

DISEÑO: Grimaldo Michelle y Lopez Jean	MATERIAL: Acero Galvanizado	<b>UCV</b>
DIBUJO: Grimaldo Michelle y Lopez Jean	CANTIDAD: 1	
REVISADO: 22/05/2013	ESCALA: 1:15	
APROBADO: 24/05/2013		
<b>NOTAS:</b>		TÍTULO: PARED COMPRESORA - LAMINA SEGURIDAD SUP.
		HOJA 1/1
UNIVERSIDAD CENTRAL DE VENEZUELA - FACULTAD DE INGENIERÍA - EIM		

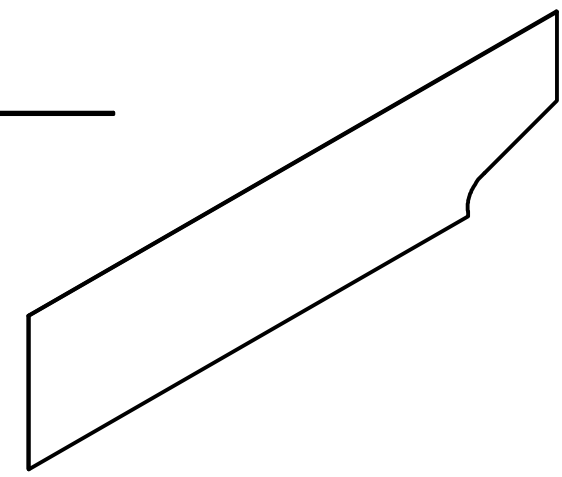

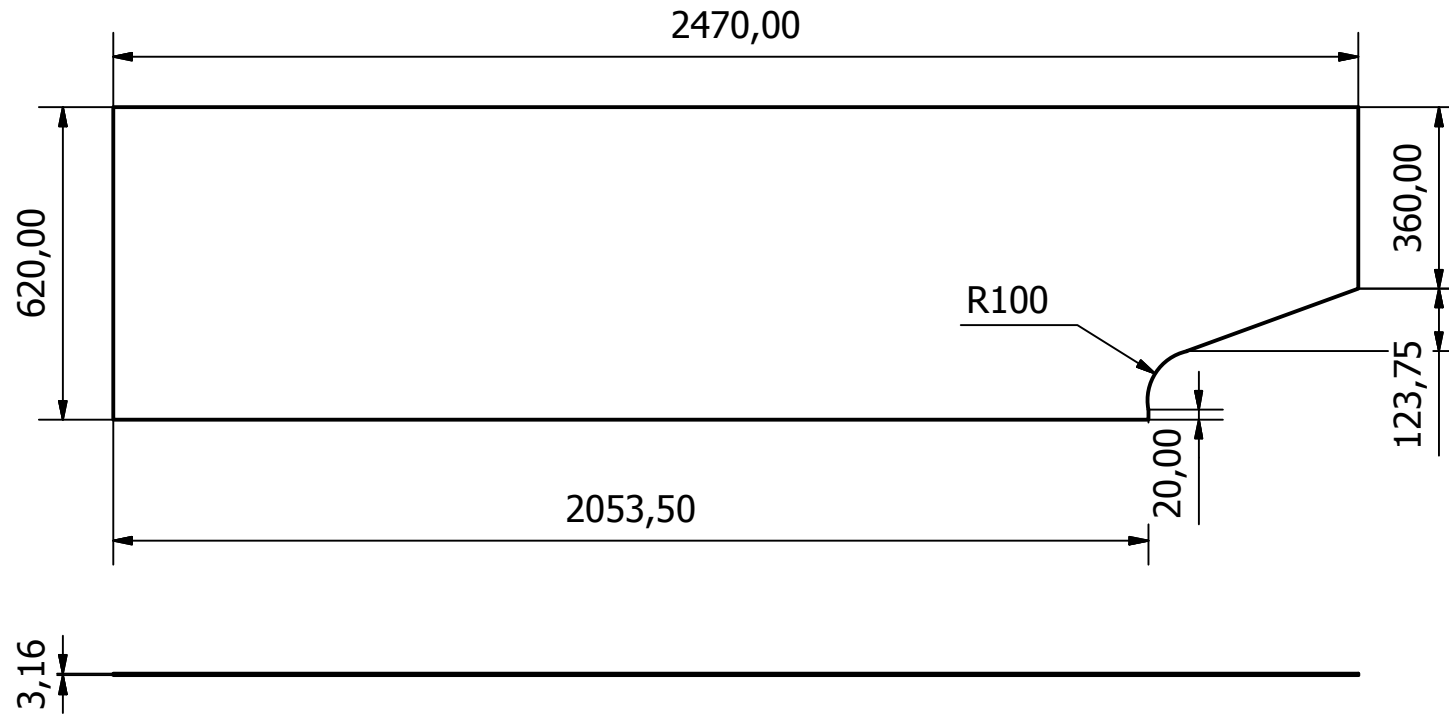

DISEÑO: Grimaldo Michelle y Lopez Jean	MATERIAL: Acero Galvanizado	<h1>UCV</h1>
DIBUJO: Grimaldo Michelle y Lopez Jean	CANTIDAD: 1	
REVISADO: 22/05/2013	ESCALA: 1:15	
APROBADO: 24/05/2013		
<b>NOTAS:</b>		TÍTULO: PARED COMPRESORA - LAMINA SEGURIDAD
		HOJA 1/1
UNIVERSIDAD CENTRAL DE VENEZUELA - FACULTAD DE INGENIERÍA - EIM		

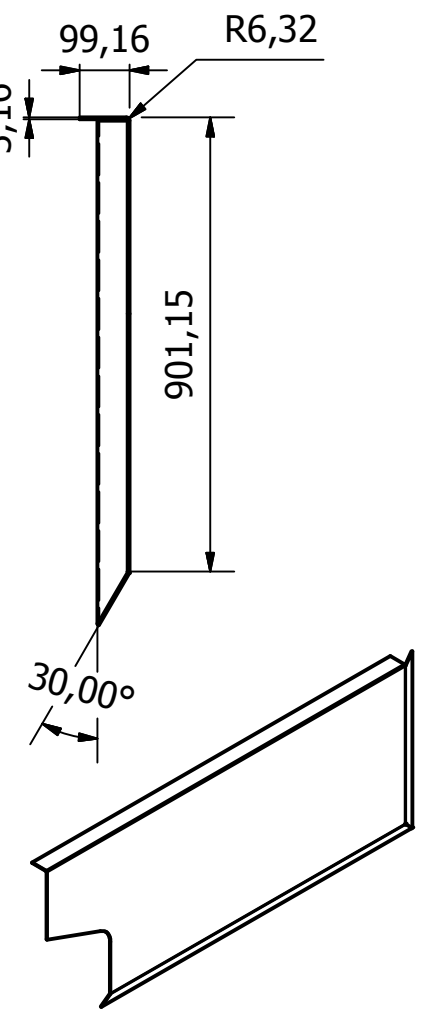
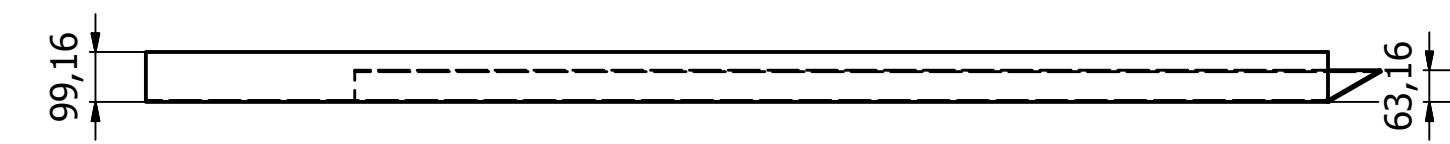
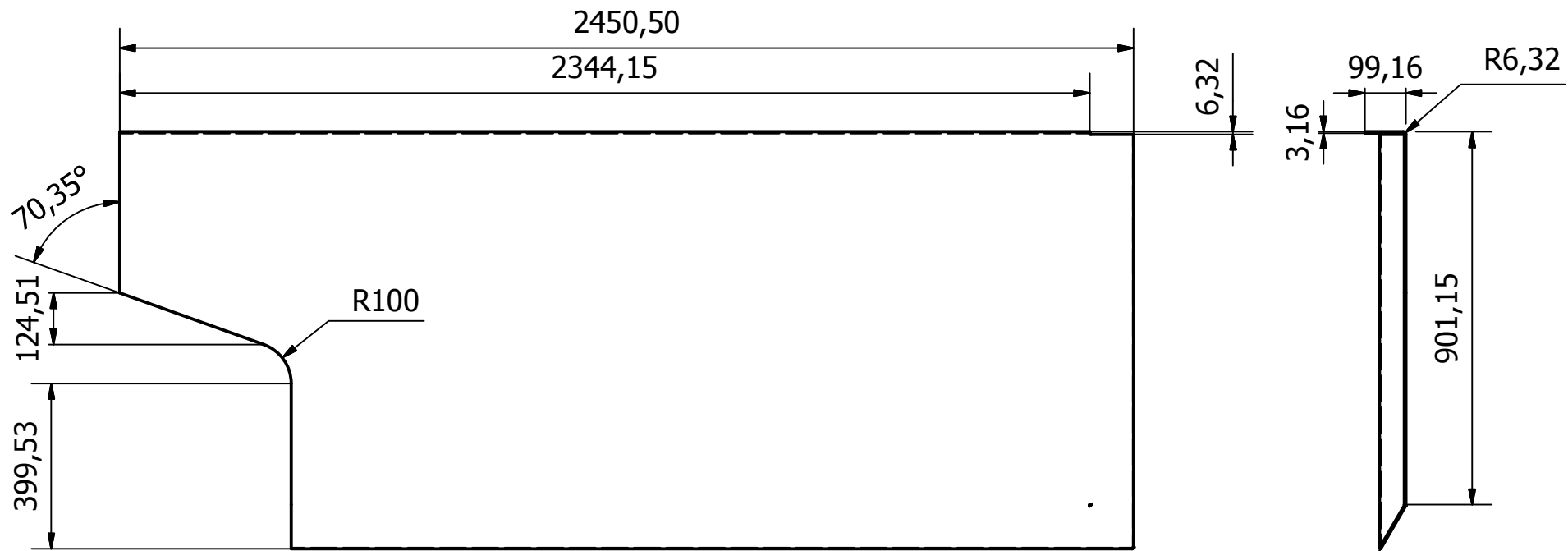

PRODUCED BY AN AUTODESK EDUCATIONAL PRODUCT

PRODUCED BY AN AUTODESK EDUCATIONAL PRODUCT

DISEÑO: Grimaldo Michelle y Lopez Jean	MATERIAL: Acero Galvanizado	<h1>UCV</h1>
DIBUJO: Grimaldo Michelle y Lopez Jean	CANTIDAD: 1	
REVISADO: 22/05/2013	ESCALA: 1:15	
APROBADO: 24/05/2013		
NOTAS:		TÍTULO: PARED COMPRESORA - PARED
		HOJA 1/1
		UNIVERSIDAD CENTRAL DE VENEZUELA - FACULTAD DE INGENIERÍA - EIM



4,83

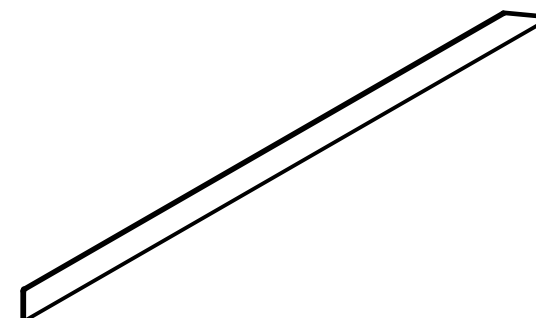
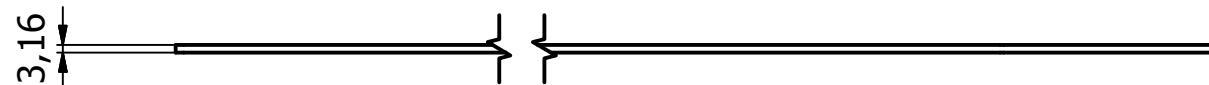
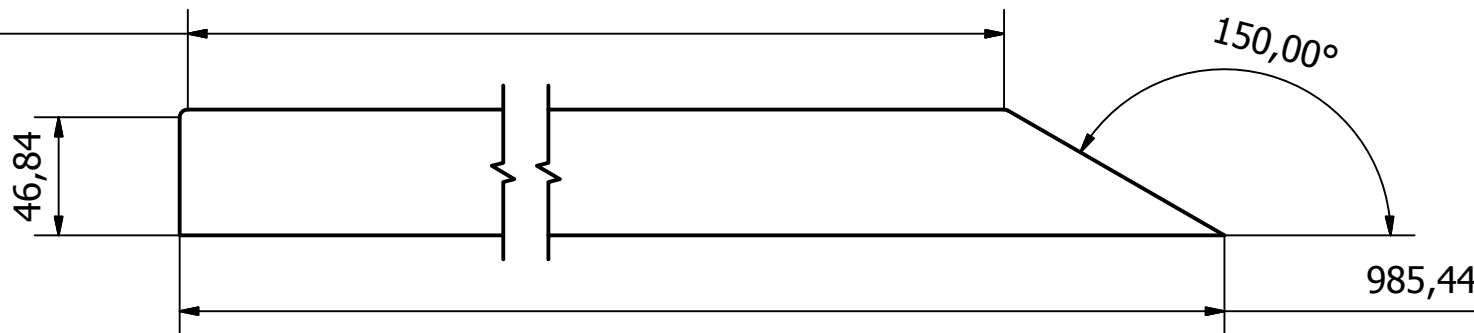

PRODUCED BY AN AUTODESK EDUCATIONAL PRODUCT

PRODUCED BY AN AUTODESK EDUCATIONAL PRODUCT

DISEÑO: Grimaldo Michelle y Lopez Jean	MATERIAL: Acero Galvanizado	<h1>UCV</h1>
DIBUJO: Grimaldo Michelle y Lopez Jean	CANTIDAD: 1	
REVISADO: 22/05/2013	ESCALA: 1:3	
APROBADO: 24/05/2013		
NOTAS:		TÍTULO: PARED COMPRESORA - REFUERZO 1
		HOJA 1/1
UNIVERSIDAD CENTRAL DE VENEZUELA - FACULTAD DE INGENIERÍA - EIM		

487,18

54,78

3,16

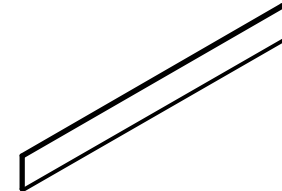

DISEÑO: Grimaldo Michelle y Lopez Jean	MATERIAL: Acero Galvanizado	<h1>UCV</h1>
DIBUJO: Grimaldo Michelle y Lopez Jean	CANTIDAD: 1	
REVISADO: 22/05/2013	ESCALA: 1:2	
APROBADO: 24/05/2013		
NOTAS:		TÍTULO: PARED COMPRESORA - REFUERZO 2
		HOJA 1/1
UNIVERSIDAD CENTRAL DE VENEZUELA - FACULTAD DE INGENIERÍA - EIM		

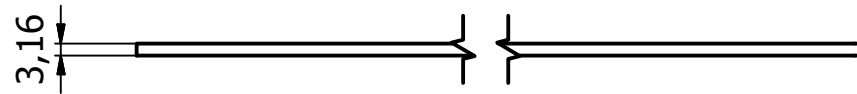
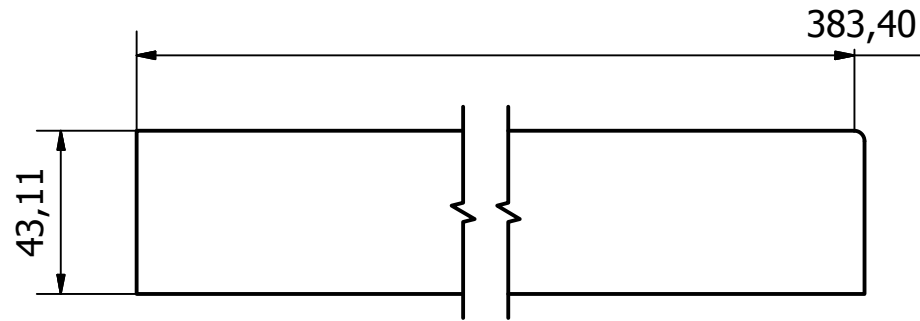

DISEÑO: Grimaldo Michelle y Lopez Jean	MATERIAL: Acero Galvanizado	<b>UCV</b>
DIBUJO: Grimaldo Michelle y Lopez Jean	CANTIDAD: 1	
REVISADO: 22/05/2013	ESCALA: 1:2	
APROBADO: 24/05/2013		
<b>NOTAS:</b>		TÍTULO: PARED COMPRESORA - REFUERZO 3
		HOJA 1/1
UNIVERSIDAD CENTRAL DE VENEZUELA - FACULTAD DE INGENIERÍA - EIM		

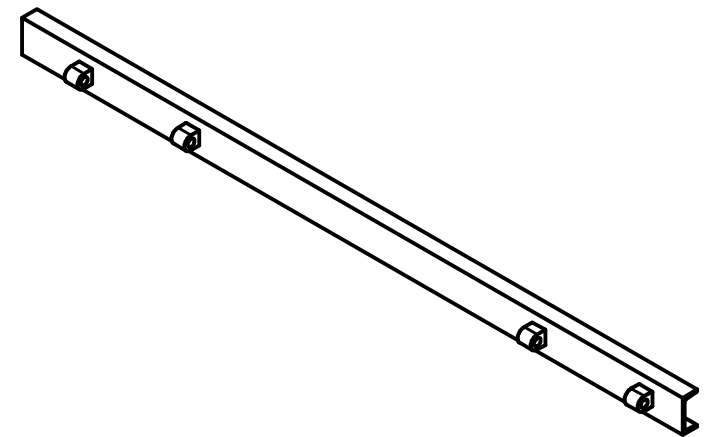
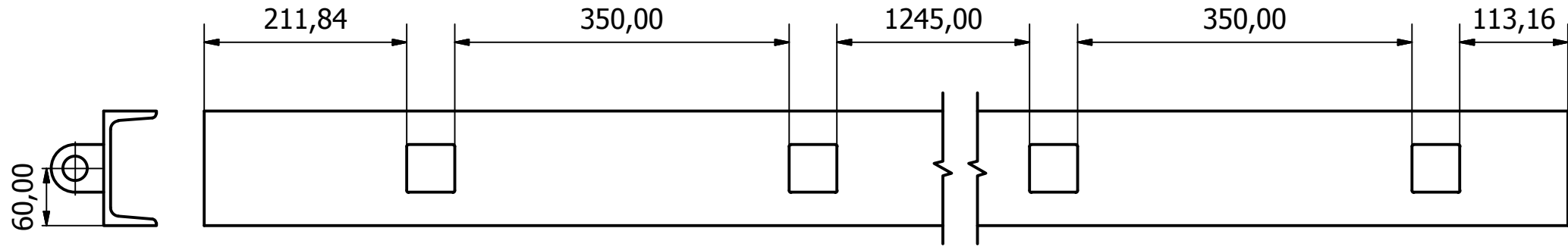

DISEÑO: Grimaldo Michelle y Lopez Jean	MATERIAL: Acero Galvanizado	<b>UCV</b>
DIBUJO: Grimaldo Michelle y Lopez Jean	CANTIDAD: 1	
REVISADO: 22/05/2013	ESCALA: 1:6	
APROBADO: 24/05/2013		
NOTAS:		TÍTULO: PARED COMPRESORA - VIGA BISAGRA
		HOJA 1/1
UNIVERSIDAD CENTRAL DE VENEZUELA - FACULTAD DE INGENIERÍA - EIM		



150,00 250,00 1345,00 250,00 255,50

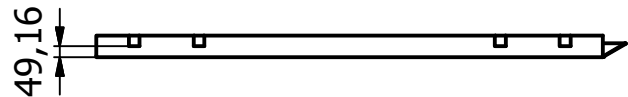
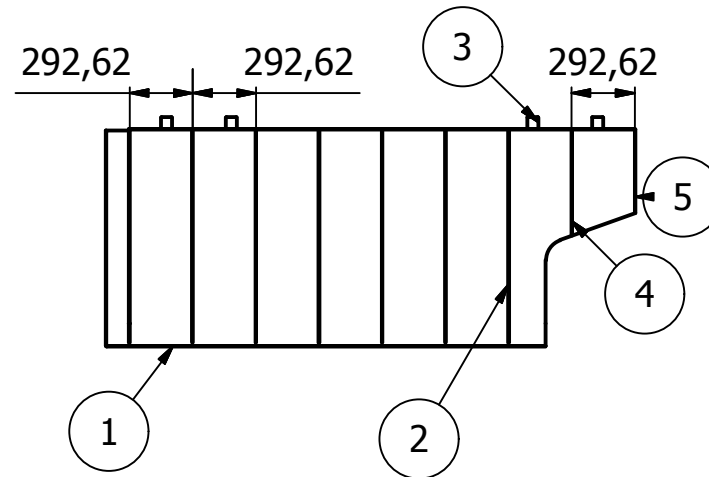
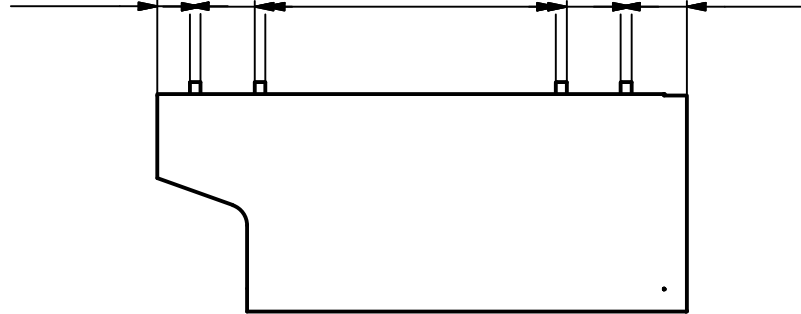

LISTA DE PARTES

ELEMENTO	NOMBRE	CANTIDAD
1	PARED COMPRESORA - PARED	1
2	PARED COMPRESORA - REFUERZO 1	7
3	BISAGRA	1
4	PARED COMPRESORA - REFUERZO 2	1
5	PARED COMPRESORA - REFUERZO 3	4

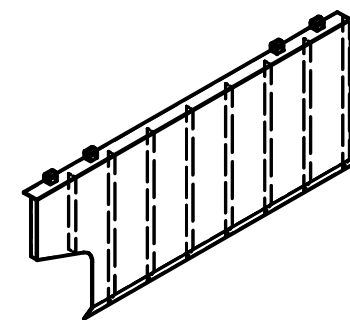

DISEÑO: Grimaldo Michelle y Lopez Jean	MATERIAL: Acero Galvanizado
DIBUJO: Grimaldo Michelle y Lopez Jean	CANTIDAD: 1
REVISADO: 22/05/2013	ESCALA: 1:35
APROBADO: 24/05/2013	

UCV

NOTAS:

TÍTULO:  
PARED COMPRESORA

HOJA 1/1

UNIVERSIDAD CENTRAL DE VENEZUELA - FACULTAD DE INGENIERÍA - EIM