

DISEÑO: Grimaldo Michelle y Lopez Jean	MATERIAL: Acero Galvanizado	<h1>UCV</h1>
DIBUJO: Grimaldo Michelle y Lopez Jean	CANTIDAD: 1	
REVISADO: 22/05/2013	ESCALA: 1:2	
APROBADO: 24/05/2013		
NOTAS:		TÍTULO: PUERTA DE ENTRADA - CARRIL
		HOJA 1/1
UNIVERSIDAD CENTRAL DE VENEZUELA - FACULTAD DE INGENIERÍA - EIM		

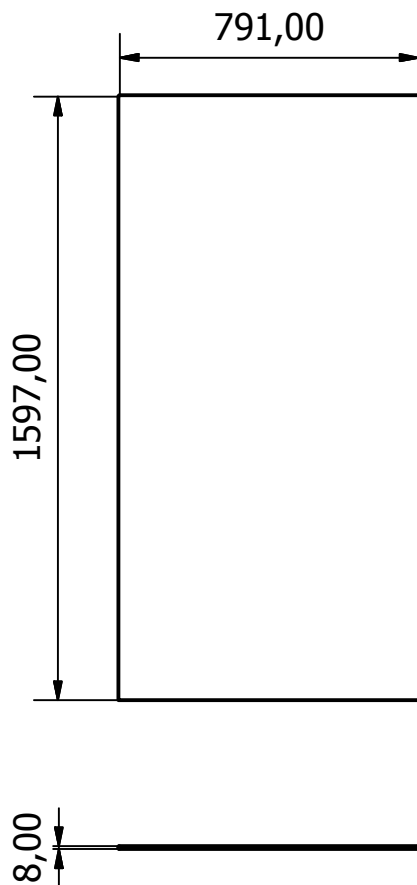



DISEÑO: Grimaldo Michelle y Lopez Jean	MATERIAL: Acero Galvanizado	UCV
DIBUJO: Grimaldo Michelle y Lopez Jean	CANTIDAD: 1	
REVISADO: 22/05/2013	ESCALA: 1:20	
APROBADO: 24/05/2013		
NOTAS:		TÍTULO: PUERTA ENTRADA - LÁMINA
		HOJA 1/1
UNIVERSIDAD CENTRAL DE VENEZUELA - FACULTAD DE INGENIERÍA - EIM		



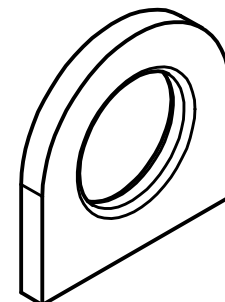
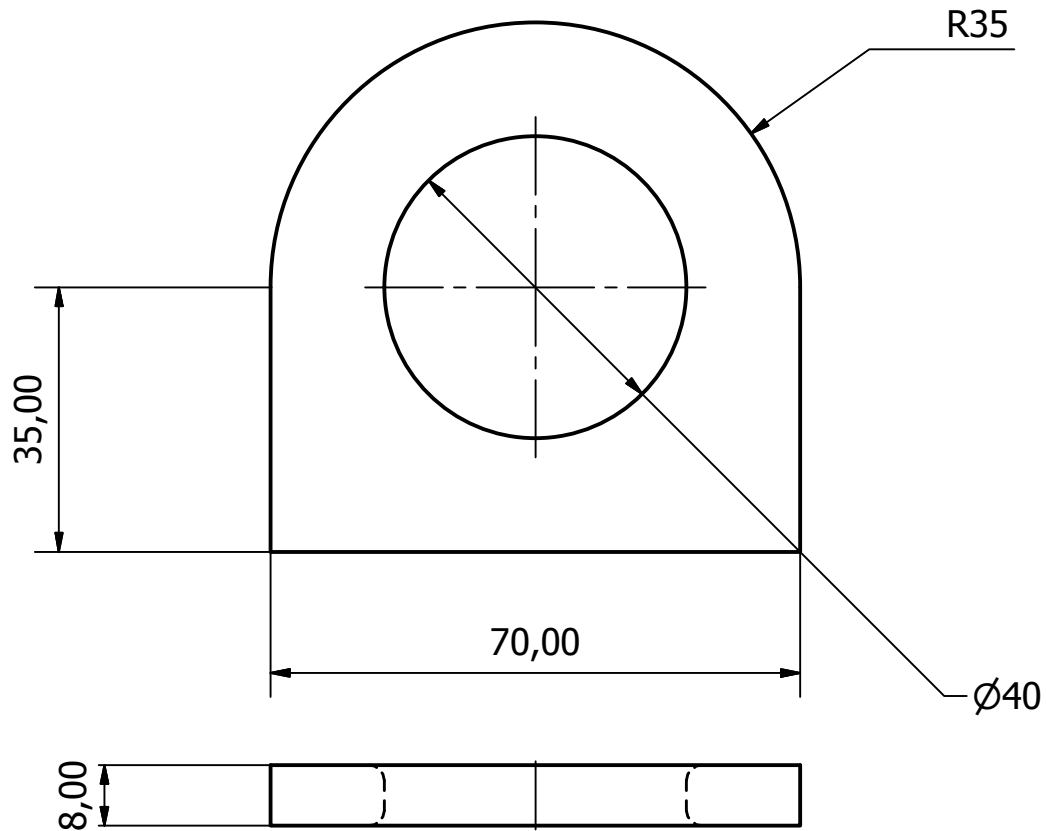

DISEÑO: Grimaldo Michelle y Lopez Jean	MATERIAL: Acero Galvanizado	<h1>UCV</h1>
DIBUJO: Grimaldo Michelle y Lopez Jean	CANTIDAD: 1	
REVISADO: 22/05/2013	ESCALA: 1:1	
APROBADO: 24/05/2013		
NOTAS:		TÍTULO: PUERTA ENTRADA - OREJA
		HOJA 1/1
UNIVERSIDAD CENTRAL DE VENEZUELA - FACULTAD DE INGENIERÍA - EIM		

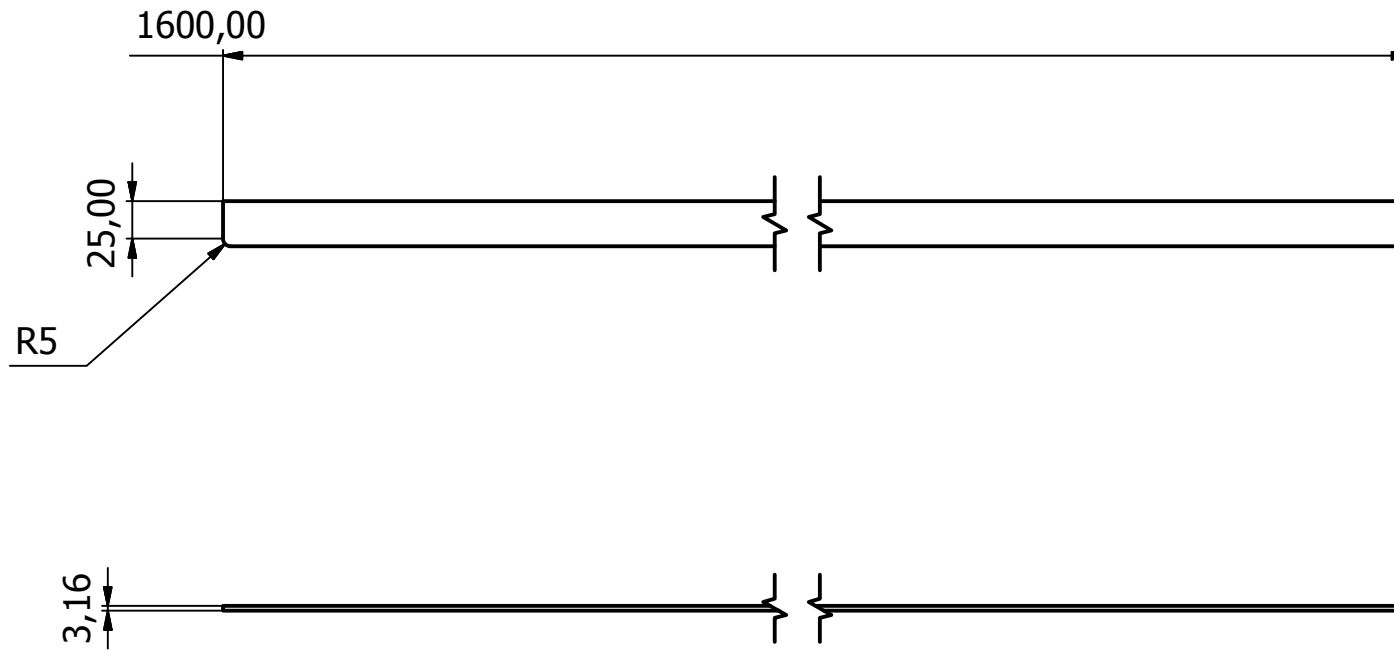

PRODUCED BY AN AUTODESK EDUCATIONAL PRODUCT

PRODUCED BY AN AUTODESK EDUCATIONAL PRODUCT

DISEÑO: Grimaldo Michelle y Lopez Jean	MATERIAL: Acero Galvanizado	<h1>UCV</h1>
DIBUJO: Grimaldo Michelle y Lopez Jean	CANTIDAD: 11	
REVISADO: 22/05/2013	ESCALA: 1:5	
APROBADO: 24/05/2013		
NOTAS:		TÍTULO: PUERTA ENTRADA - REFUERZO
		HOJA 1/1
UNIVERSIDAD CENTRAL DE VENEZUELA - FACULTAD DE INGENIERÍA - EIM		

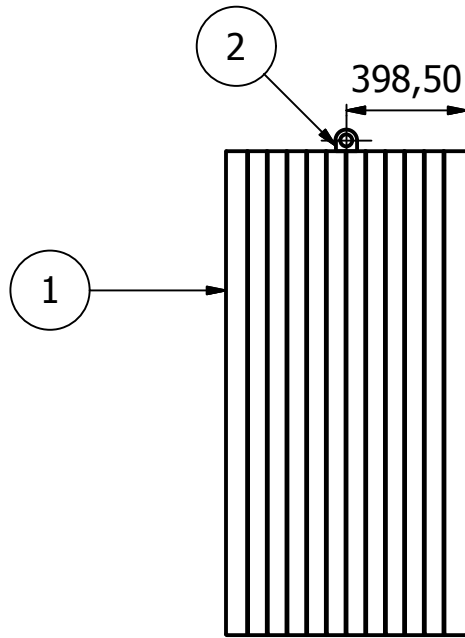

LISTA DE PARTES		
ELEMENTO	NOMBRE	CANTIDAD
1	PUERTA DE ENTRADA - LÁMINA	1
2	PUERTA DE ENTRADA - OREJA	1
3	PUERTA DE ENTRADA - REFUERZO	11

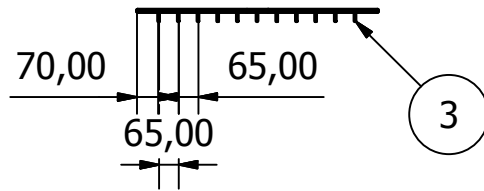
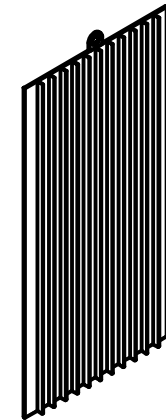

DISEÑO: Grimaldo Michelle y Lopez Jean	MATERIAL: Acero Galvanizado	<h1>UCV</h1>
DIBUJO: Grimaldo Michelle y Lopez Jean	CANTIDAD: 1	
REVISADO: 22/05/2013	ESCALA: 1:25	
APROBADO: 24/05/2013		
NOTAS:		TÍTULO: PUERTA ENTRADA
		HOJA 1/1
		UNIVERSIDAD CENTRAL DE VENEZUELA - FACULTAD DE INGENIERÍA - EIM